

Serrature a levetta serie 400-500

Modello 423D

Caratteristiche:

- serratura meccanicamente Ri-Programmabile
- realizzata in ottone
- finitura esterna nichel
- rotazione 90° antioraria
- resistente ad apertura con metodo "bumping"
- resistente ad apertura con grimaldelli - "picking"
- versione HS con spine antiforatura

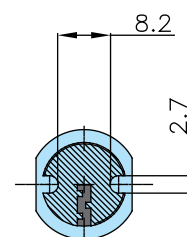
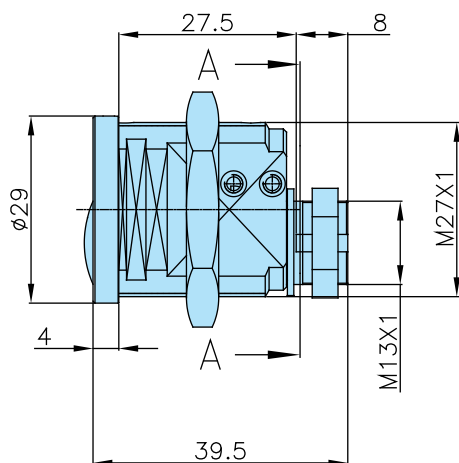
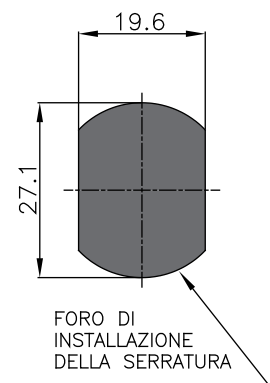
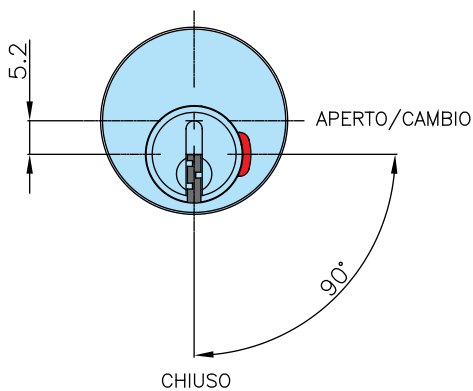

A-A